

2x



2x



For installation, use expansion plug suitable for wall construction.

Not recommended for plaster walls.

Max. load 5 kg

1.

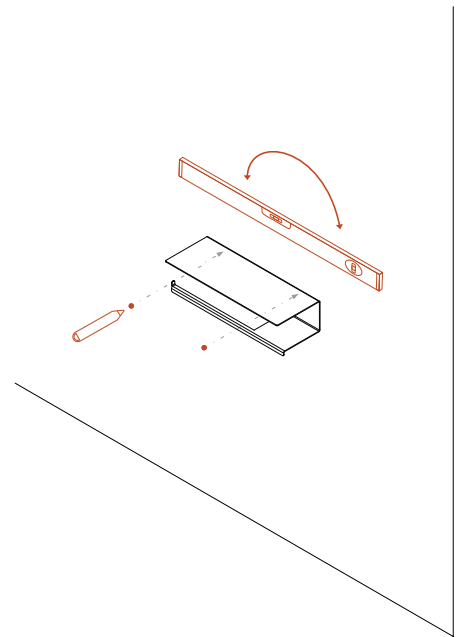

2.

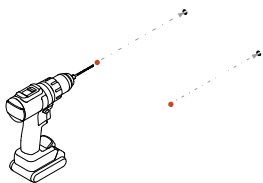

Drill: \varnothing 6mm
Hole depth: min. 70mm

3.

