

F3EV1014 | 2030040093

PRODUCT GROUP (PG) : Taps | ARTICLE FAMILY (AF) : Electronic tap | ARTICLE GROUP (AG) : F3EV1010 ++ |
MODEL RANGE : F3 | LIFECYCLE : New

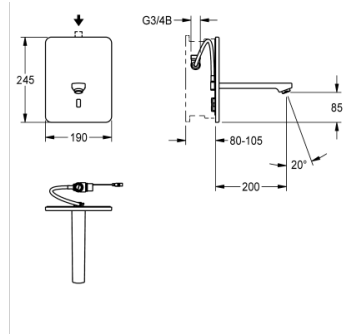

TECHNICAL DATA

gross weight	1.76 kg
net weight	1.67 kg
functional principle	ELECTRONIX-C
type of mixing	No
power supply connection	BATTERY-6-V
type of mounting	in-wall installation with box
type of tap	in-wall tap
calculation flow rate cold water	0.10 liter per second
default automatic hygiene flushing	24H-AFTER-ACTIVITY
depressurised	no
diameter nominal	DN 15
material casing	stainless steel
material fitting	brass
minimum flow pressure	1.00 bar
position of power connection	from top
power consumption	1,5
protective shutdown	YES
sound insulation	no
spout projection	200.00 mm
surface finish casing	satin finished
surface finish fitting	chromed
thermal disinfection	automatic thermal disinfection installed
type of operation	SENSOR-OPERATION
type of sensor	OPTO-ELEC-SENSOR
volume flow rate at 3 bar	0.05 liter per second

F3EV1014 | 2030040093

PRODUCT GROUP (PG) : **Taps** | ARTICLE FAMILY (AF) : **Electronic tap** | ARTICLE GROUP (AG) : **F3EV1010 ++** |
MODEL RANGE : **F3** | LIFECYCLE : **New**

ACCESSORIES

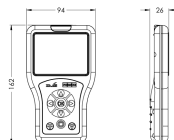

REMOTE CONTROL

2030036654

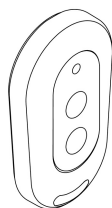

REMOTE CONTROL

2030036849

MANDATORY ACCESSORY

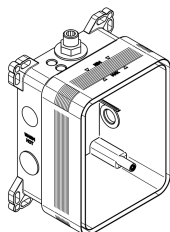

BASIC INSTALLATION KIT

2030036142
